

ATTENZIONE - ATTENTION - ACHTUNG

- Per lo smontaggio degli utensili utilizzare sempre la chiave di contrasto come indicato nel manuale d'uso.
- For disassembly of the tools use always the contrast key as mentioned in the user instructions.
- Fuer das Abmontieren der Werkzeuge immer den Gegenschlüssel benutzen wie in der Bedienungsanleitung erwahnt.

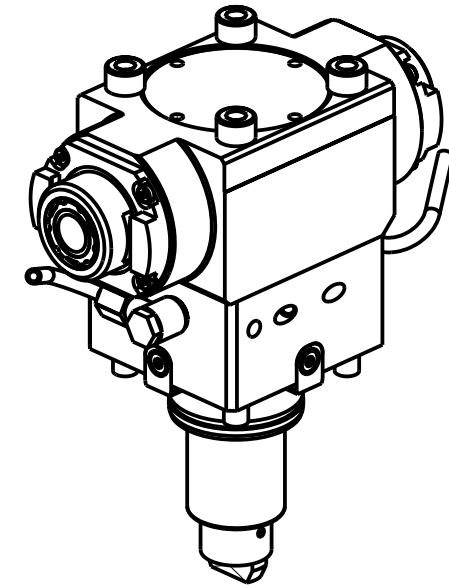
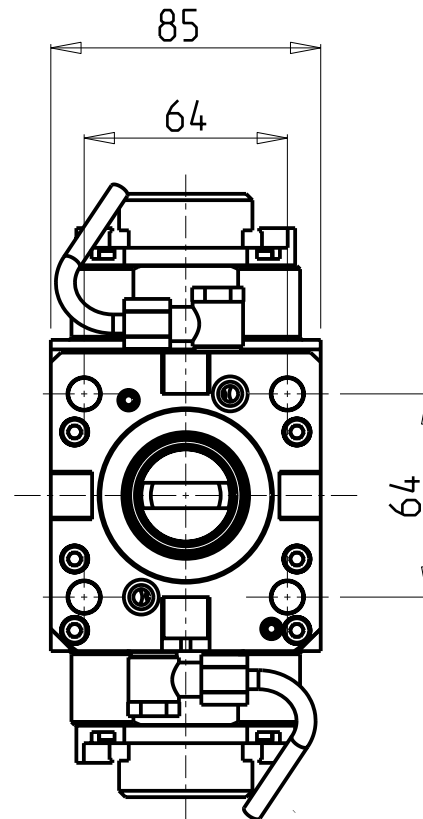
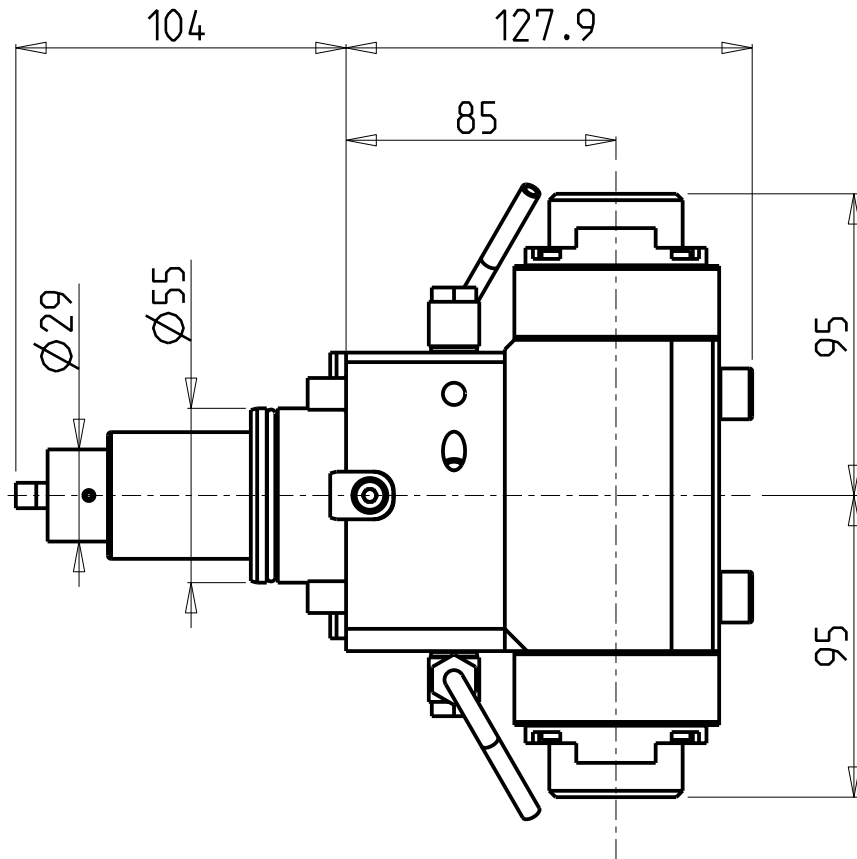

- Chiave inclusa
- Key included
- Schluessel inbegriffen

Cod. MT	Mandrino Spindle Spindel	I	RPM	Coppia Max Max Torque Max Drehmoment	Reversibile lato mandrino/contromandrino Reversible sub/main spindle side Umkehrbare Spindel-seite/ Gegenspindel-seite	Lubrificazione est. Ext. coolant Aussenkuehlung	CHIAVI NON INCLUSE Keys not included Schluessel nicht einbegriffen		
DW 03932225	ERA25+ERA25	1:2	12000	30Nm	X	X	CHUB27	CHTAER25ZC	SAU0070027

HARD INGE
MOD: T-51/65 12ST. (BMT55)

MODULO MOTORIZZATO ASSIALE BISPORGENTE MOLTIPLICATO I=1:2 H=85mm
Axial geared-up I=1:2 opposite face twin driven tool H=85mm
Axial angetriebenes Werkzeug halb vorspringend uebersetzt I=1:2 H=85mm

Subject to change without notice.

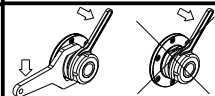

M.T. srl
Via Casino Albini 480
Tel. 0541/956034-957884
Fax 0541/956341
47842 S. GIOVANNI IN M. (RN)
e-mail: mtma@mtmarchetti.com
http://www.mtmarchetti.com



PAGINA HRD250-2-30