

versione dx
right version
version rechts

versione sx
left version
version links

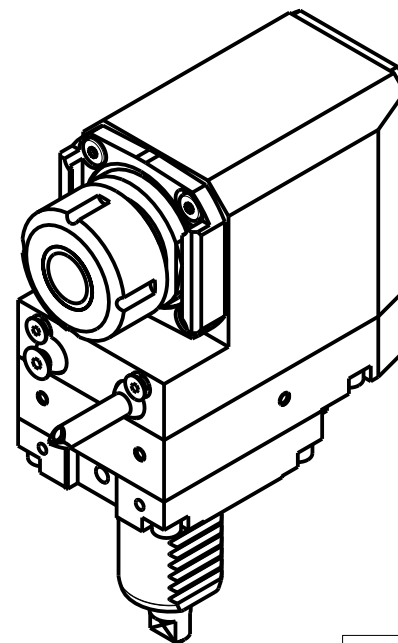
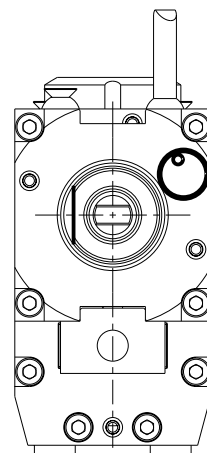
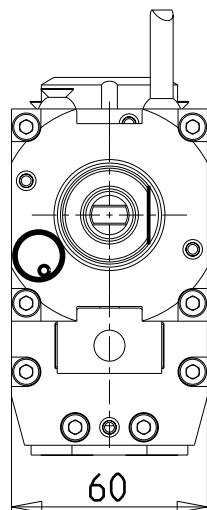

- Chiave inclusa
- Key included
- Schlüssel inbegriffen

Cod. MT		Mandrino Spindle Spindel	I	RPM	Coppia Max Max Torque Max Drehmoment	Lubrificazione int. Coolant through Innenkuehlung	Lubrificazione est. Ext. coolant Aussenkuehlung	A1	A2	B	CHIAVI NON INCLUSE Keys not included Schlüssel nicht einbegriffen		
versione dx right version version rechts	versione sx left version version links												
DUP0100120	DUP0101120	ER20	1:1	6000	32Nm	-	X	41.16	-	73.5	-	CHSTER20	OKU0290009
DUP0100220	DUP0101220	ER20	1:1	6000	32Nm	P=70bar	X	41.16	-	83.5	-	CHSTER20	OKU0290009
DUP0100320	DUP0101320	ERA20	1:1	6000	32Nm	-	X	24.5	-	73.5	CHUB22	CHTAER20ZC	OKU0290009
DUP0100420	DUP0101420	ERA20	1:1	6000	32Nm	P=70bar	X	24.5	-	83.5	CHUB22	CHTAER20ZC	OKU0290009
DUP0100125	DUP0101125	ER25	1:1	6000	32Nm	-	X	42.16	-	73.5	-	CHSTER25	OKU0290009
DUP0100225	DUP0101225	ER25	1:1	6000	32Nm	P=70bar	X	42.16	-	83.5	-	CHSTER25	OKU0290009
DUP0100325	DUP0101325	ERA25	1:1	6000	32Nm	-	X	28.5	-	73.5	CHUB27	CHTAER25ZC	OKU0290009
DUP0100425	DUP0101425	ERA25	1:1	6000	32Nm	P=70bar	X	28.5	-	83.5	CHUB27	CHTAER25ZC	OKU0290009
DUP0100516	DUP0101516	WELDON16	1:1	6000	32Nm	-	X	-	27.5	73.5	-	-	-

DIPLOMATIC
VDI 30

MODULO MOTORIZZATO RADIALE ARRETRATO VDI30 H=85mm
Radial rear-set driven tool VDI30 H=85mm
Radial angetriebenes Werkzeug zurueckversetzt VDI30 H=85mm

Subject to change without notice.

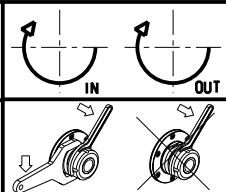

M.T. srl
Via Casino Albini 480
Tel. 0541/956034-957884
Fax 0541/956341
47842 S. GIOVANNI IN M. (RN)
e-mail: mtma@mtmarchetti.com
http://www.mtmarchetti.com



PAGINA DUP015-1-70