

ATTENZIONE - ATTENTION - ACHTUNG

- VERIFICARE LE MISURE DI INGOMBRO PER POSSIBILE INTERFERENZA SU ALCUNI MODELLI DI MACCHINE
- Please check the overall sizes for possible interferences on some machine models
- Bitte überprüfen sie das ausmass um mögliche interferenzen auf einigen maschinen modellen zu vermeiden

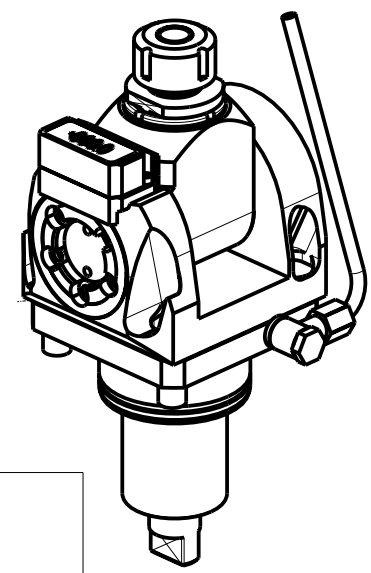

Cod. MT	Mandrino Spindle Spindel	I	RPM	Coppia Max Max Torque Max Drehmoment	Reversibile lato mandrino/contromandrino Reversible sub/main spindle side Umkehrbare Spindelseite/ Gegenspindelseite	Lubrificazione est. Ext. coolant Aussehenkuehlung	A	A1	D	L	CHIAVI INCLUSE Keys included Schlüssel inbegriffen		
											CH_VTCROCE_M08	CHUB36	CHESL10
DW 01850120	ER20	1:1	6000	40Nm	X	X	85.16	-	-	-	CHSTER20	CHUB36	CHESL10
DW 01850125	ER25	1:1	6000	40Nm	X	X	86.16	-	-	-	CHSTER25	CHUB36	CHESL10
DW 01850516	Ø16x17	1:1	6000	40Nm	X	X	-	65	16	17	CH_VTCROCE_M08	CHUB36	CHESL10
DW 01850522	Ø22x19	1:1	6000	40Nm	X	X	-	66	22	19	CH_VTCROCE_M10	CHUB36	CHESL10
DW 01850519	Ø3/4"x3/4"	1:1	6000	40Nm	X	X	-	65	3/4"	3/4"	CH_VTCROCE_M08	CHUB36	CHESL10

SPINNER
MOD: TC800 SMCY (BMT65)

MODULO MOTORIZZATO ORIENTABILE ±90° CON NONIO DIGITALE H=54mm
±90° adjustable angle driven tool with digital display H=54mm
Angetriebenes Werkzeug schwenkbar ±90° mit digital display H=54mm

Subject to change without notice.

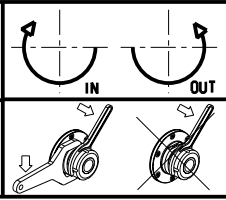

M.T. srl
Via Casino Albini 480
Tel. 0541/956034-957884
Fax 0541/956341
47842 S. GIOVANNI IN M. (RN)
e-mail: mtma@mtmarchetti.com
http://www.mtmarchetti.com



PAGINA SPN333-2-01